



For more add-on packs and building instructions, please visit:
<http://learn.makeblock.com/en/gizmos/>

We appreciate your opinions about our products, please contact us
with your suggestion at:

Makeblock Co., Ltd.

Technical support: tec-support@makeblock.com

Tel: +86 (0) 755-26392228

Address: 4th Floor, Building C3, Nanshan iPark, No.1001 Xueyuan Avenue,
Nanshan District, Shenzhen, Guangdong Province, China



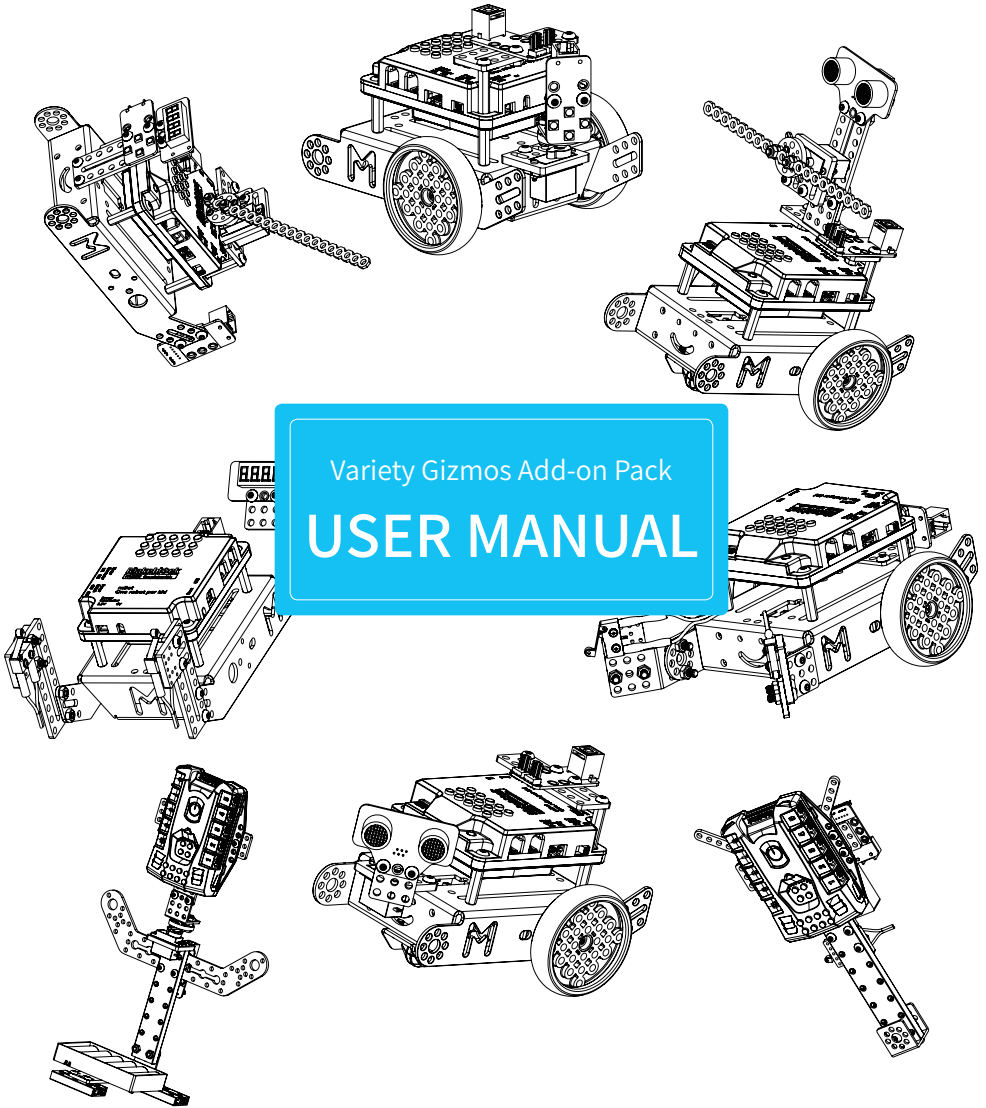

Index

P02 Parts List

P04 mBot Add-on Cases

P04 Antenna Car

P07 Timer

P10 Traffic Gate

P14 Dancing Cat

P18 Head Shaking Cat

P22 Light-Emitting Cat

P26 mBot Ranger Add-on Cases

P26 Sunflower

P30 Magic Stick

Parts List

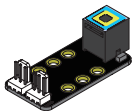

1 ×
RJ25 Adapter
Module



1 ×
RGB LED Module

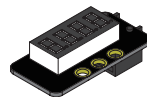

1 ×
Segment
Serial Display

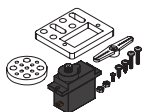

1 ×
9g Micro Servo Pack

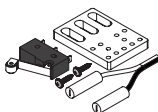

2 ×
Micro Switch B



2 ×
Plate 45°



2 ×
Plate 11

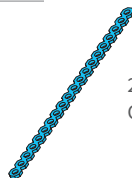

2 ×
Cutttable Linkage



2 ×
Bracket 3×3



2 ×
Bracket 120° 3×3



4 ×
RJ25 Cable



4 ×
M4×25mm Brass Stud



1 ×
Wrench 5mm&7mm



20 ×
M4×8mm Screw



12 ×
M4×14mm Screw



4 ×
M4×22mm Screw



12 ×
M4 Nut



10 ×
Plastic Spacer 4×7×3mm

Reference for Parts (Ratio 1:1)



M4×8mm Screw



M2×10mm Screw

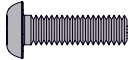

M4×14mm Screw



M2×5mm Screw



M4×22mm Screw



Plastic Spacer
4×7×3mm



M4 Nut



M2 Nut

Antenna Car



mBot Chassis (1)



mBot Motor (2)



mBot M3x25mm Screw (4)



mBot M3 Nut (4)

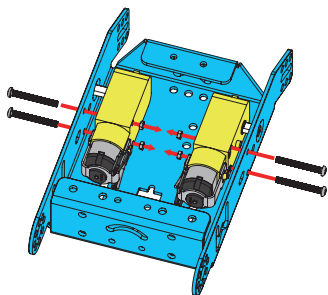

01

02



mBot Mini Wheel (1)



M4x8mm Screw (2)

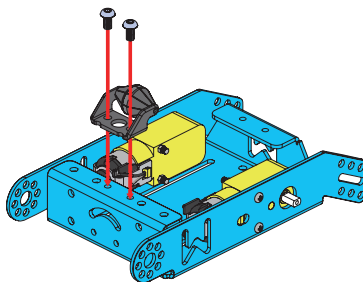

03

04



mBot Wheel (2)



mBot Self-drilling Screw (2)

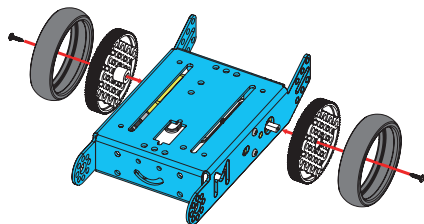

Bracket 3x3 (1)



M4x8mm Screw (2)

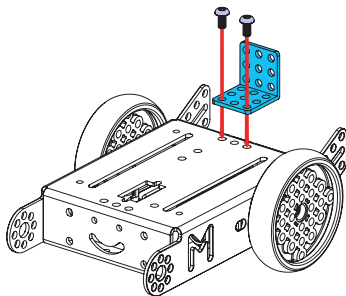



RJ25 Adapter Module (1)



M4 x 8mm Screw (2)



M4 Nut (2)

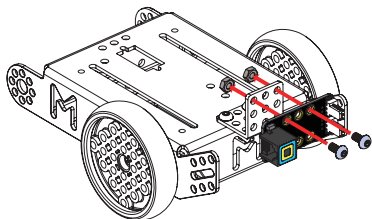

M4 x 25mm Brass Stud (4)



M4 x 8mm Screw (4)



mCore (1)

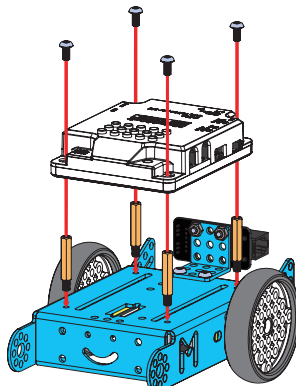

05

06

07

08



Micro Switch (2)



Micro Switch Cable (2)

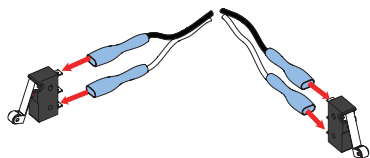

Micro Switch Bracket (2)



Micro Switch
Self-drilling Screw (4)

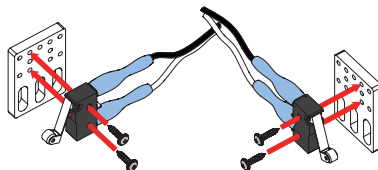



Bracket 120° 3×3 (2)



M4×14mm Screw (4)



M4 Nut (4)

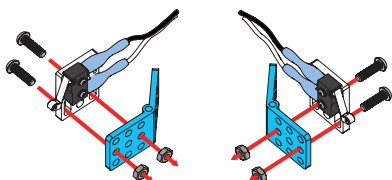

M4×14mm Screw (4)



M4 Nut (4)

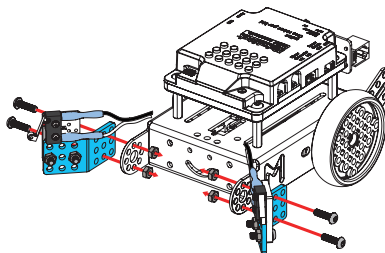

09

10

11

12



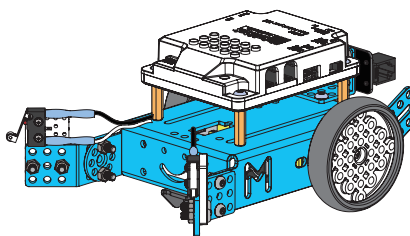
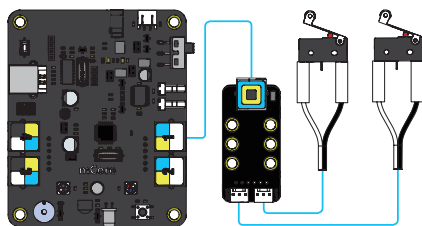

Please refer to the figure below to complete the wiring.

Good job!

You have finished the construction. To learn more, please visit: <http://learn.makeblock.com/en/gizmos/>



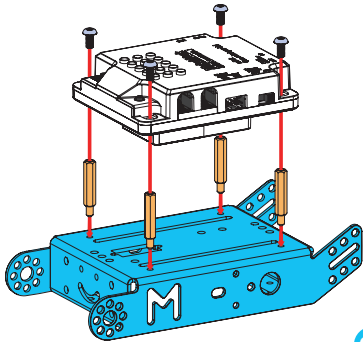

Timer

-  M4x25mm Brass Stud (4)
-  M4x8mm Screw (4)
-  mCore (1)
-  mBot Chassis (1)



01

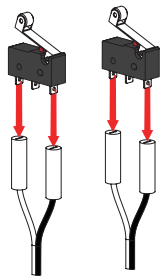

-  Micro Switch (2)
-  Micro Switch Cable (2)



02



-  Micro Switch Bracket (2)
-  Micro Switch Self-drilling Screw (4)

03

-  Plate I1 (2)
-  M4x14mm Screw (4)
-  M4 Nut (4)

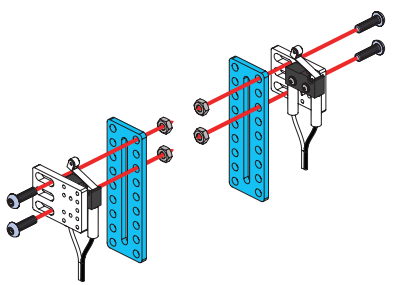
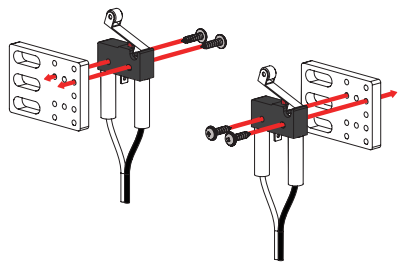
04





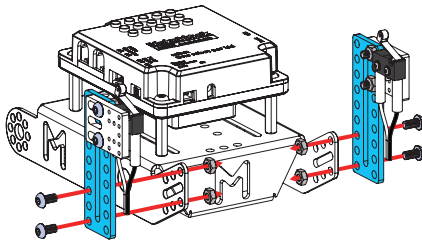

-  M4 × 8mm Screw (4)
-  M4 Nut (4)



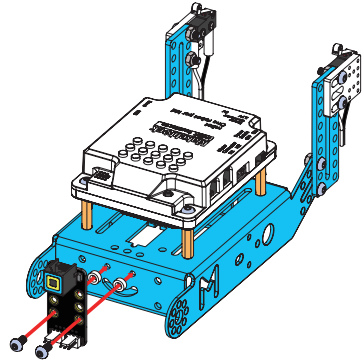



05 06
07 08

-  RJ25 Adapter Module (1)
-  M4 × 8mm Screw (2)
-  Plastic Spacer 4 × 7 × 3mm (2)

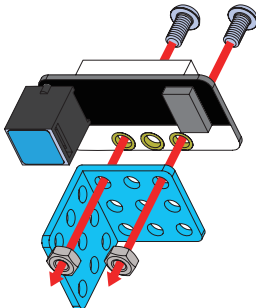

-  Segment Serial Display (1)
-  Bracket 3 × 3 (1)
-  M4 × 8mm Screw (2)
-  M4 Nut (2)



-  Plate 45° (1)
-  M4 × 8mm Screw (2)
-  M4 Nut (2)

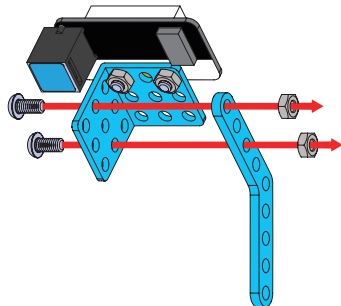



M4 × 8mm Screw (2)



M4 Nut (2)

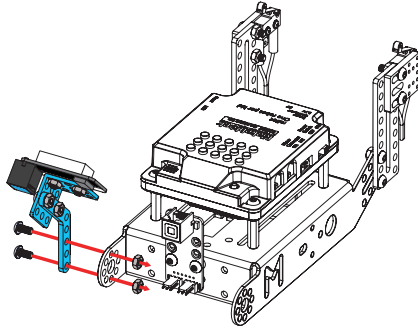

Please refer to the figure below to complete the wiring.

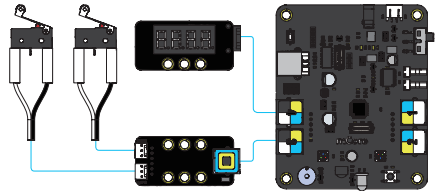

09

10



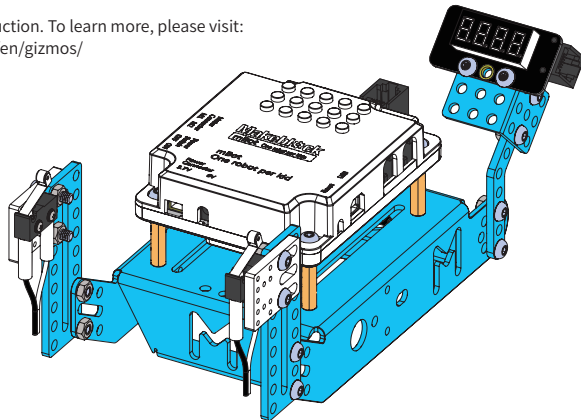

11

Good job!



You have finished the construction. To learn more, please visit:
<http://learn.makeblock.com/en/gizmos/>



Traffic Gate

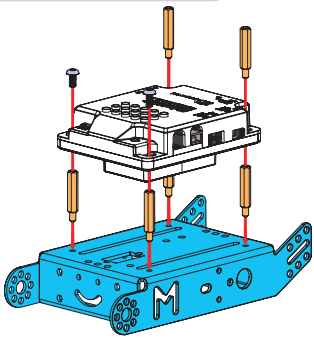



-  M4 x 25mm Brass Stud (6)
-  M4 x 8mm Screw (2)
-  mCore (1)
-  mBot Chassis (1)

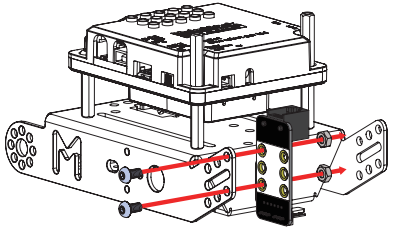



-  RJ25 Adapter Module (1)
-  M4 x 8mm Screw (2)
-  M4 Nut (2)





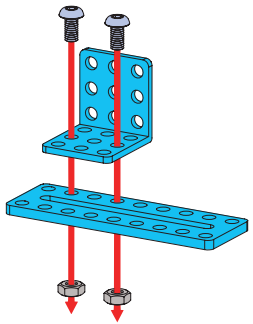

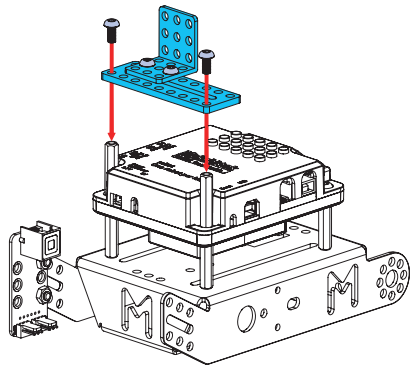

01 02
03 04

-  Bracket 3 x 3 (1)
-  Plate 1 x 1 (1)
-  M4 x 8mm Screw (2)
-  M4 Nut (2)



-  M4 x 8mm Screw (2)



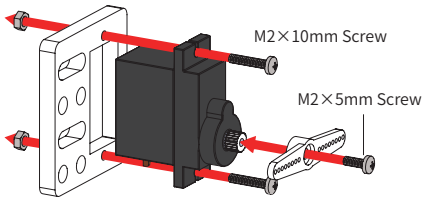

-  9g Micro Servo (1)
-  9g Micro Servo Bracket (1)
-  Servo Arm (1)
-  M2 x 5mm Screw (1)
-  M2 x 10mm Screw (2)
-  M2 Nut (2)



05

06

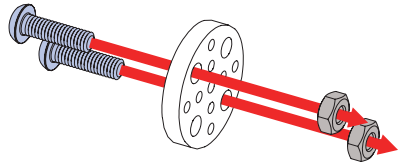

-  9g Micro Servo Hub (1)
-  M4 x 14mm Screw (2)
-  M4 Nut (2)



-  9g Micro Servo Self-drilling Screw (2)

07

08

-  M4 x 14mm Screw (2)
-  M4 Nut (2)

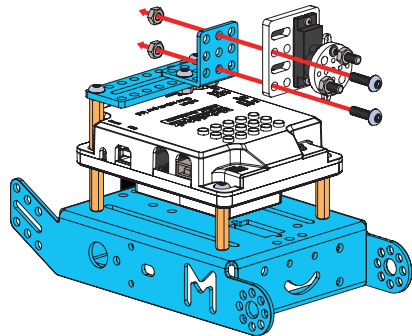
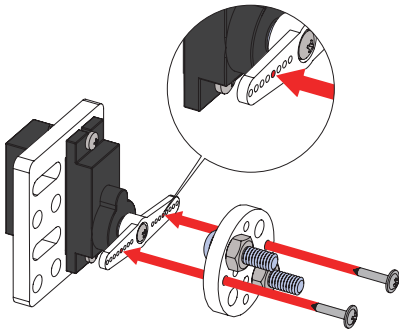



Cutttable Linkage (1)



M4 Nut (2)

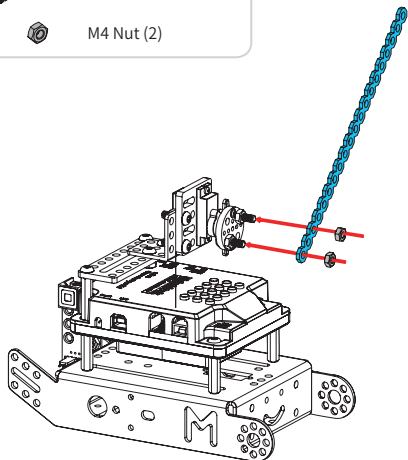

RGB LED Module (1)



Plate I1 (1)



M4 x 14mm Screw (2)



M4 Nut (2)



Plastic Spacer 4 x 7 x 3mm (2)

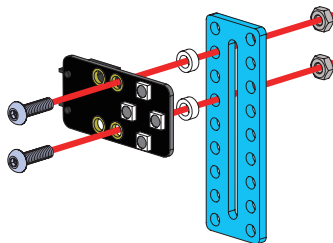

09

10



Segment Serial Display (1)



M4 x 8mm Screw (2)



M4 Nut (2)

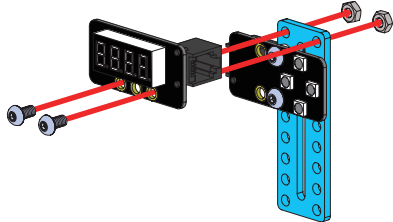

11

12



M4 x 8mm Screw (2)

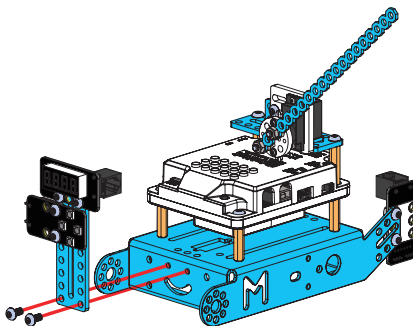

Please refer to the figure below to complete the wiring.

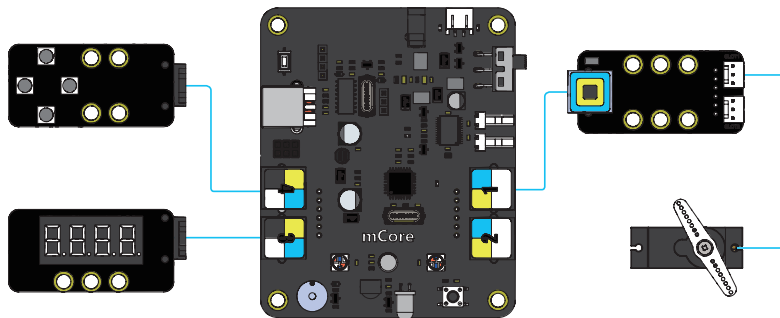

13



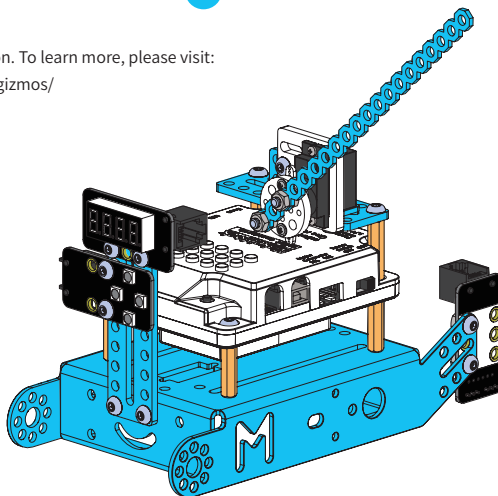

14

Good job!



You have finished the construction. To learn more, please visit:
<http://learn.makeblock.com/en/gizmos/>



Dancing Cat

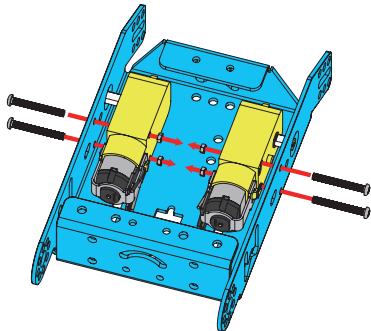

-  mBot Chassis (1)
-  mBot Motor (2)
-  mBot M3x25mm Screw (4)
-  mBot M3 Nut (4)



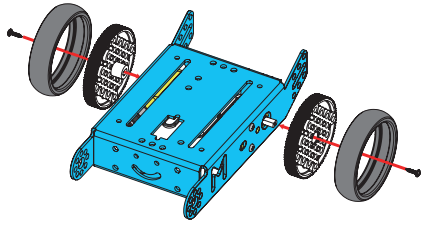



-   mBot Wheel (2)
-  mBot Self-drilling Screw (2)



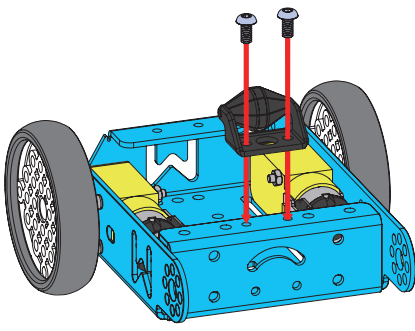



01 02
03 04

-  mBot Mini Wheel (1)
-  M4x8mm Screw (2)

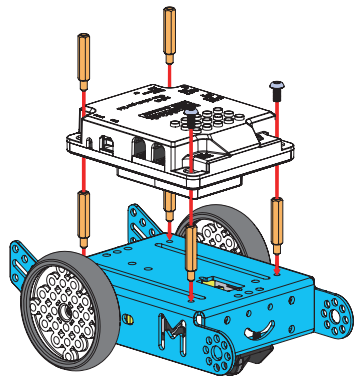



-  M4x25mm Brass Stud (6)
-  M4x8mm Screw (2)
-  mCore (1)

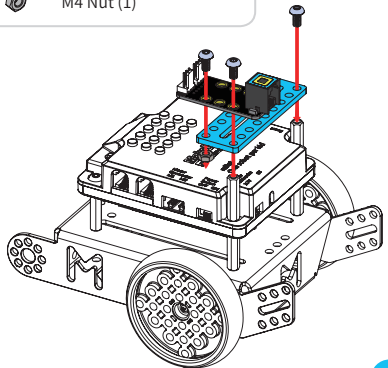

-  RJ25 Adapter Module (1)
-  Plate I1 (1)
-  M4x8mm Screw (3)
-  M4 Nut (1)





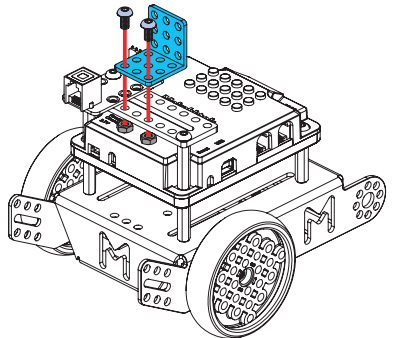

05

-  Bracket 3x3 (1)
-  M4x8mm Screw (2)
-  M4 Nut (2)







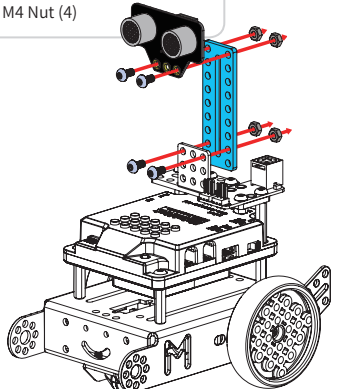

06

-  mBot Ultrasonic Sensor (1)
-  Plate I1 (1)
-  M4x8mm Screw (4)
-  M4 Nut (4)



07

-  9g Micro Servo (1)
-  9g Micro Servo Bracket (1)
-  Servo Arm (1)
-  M2x5mm Screw (1)
-  M2x10mm Screw (2)
-  M2 Nut (2)

M2x5mm Screw

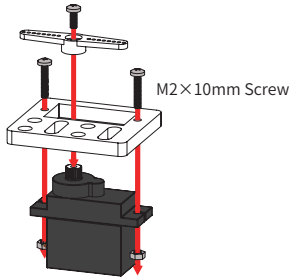



08

 9g Micro Servo Hub (1)

 M4 x 14mm Screw (2)

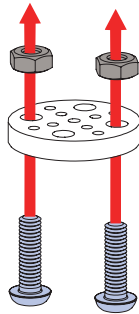
 M4 Nut (2)



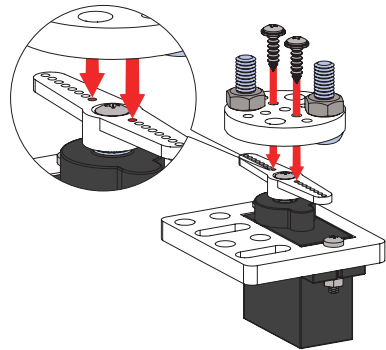

 9g Micro Servo Self-drilling Screw (2)



09

10

 M4 x 25mm Brass Stud (2)

 M4 x 8mm Screw (2)

 M4 Nut (2)

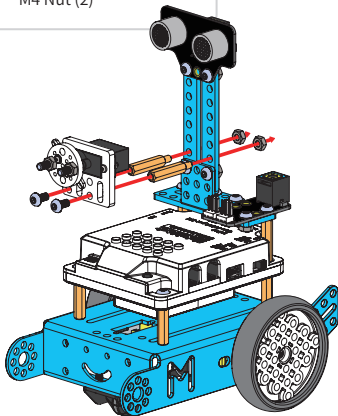

11

12

 Cuttable Linkage (1)

 M4 Nut (2)

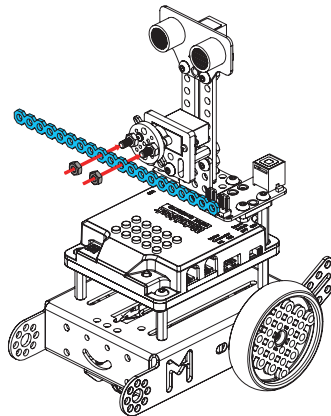

Please refer to the figure below to complete the wiring.

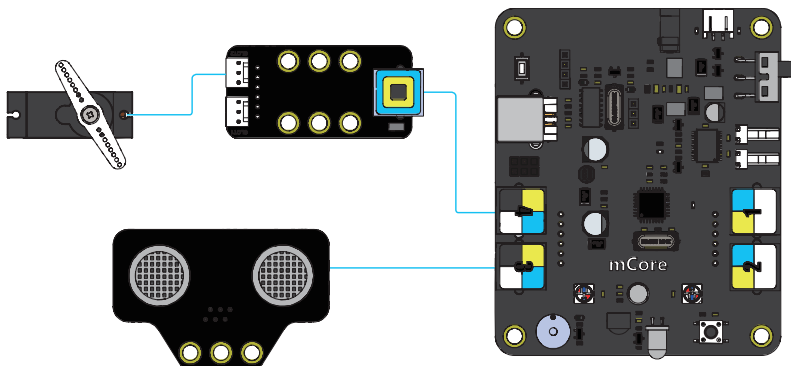

13



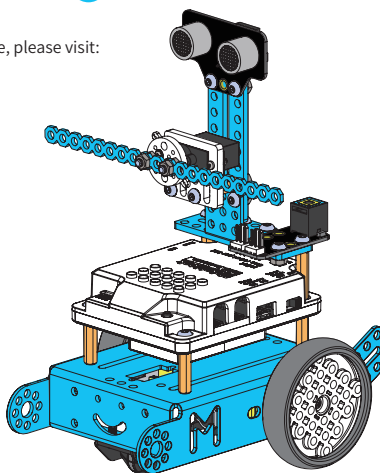

14

Good job!



You have finished the construction. To learn more, please visit:
<http://learn.makeblock.com/en/gizmos/>



Head Shaking Cat

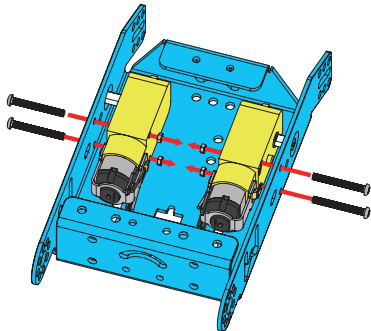

-  mBot Chassis (1)
-  mBot Motor (2)
-  mBot M3×25mm Screw (4)
-  mBot M3 Nut (4)



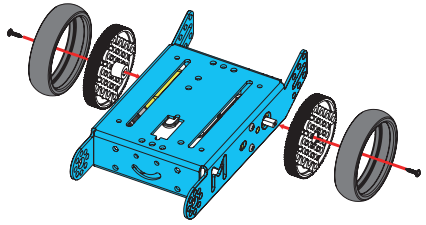

-  mBot Wheel (2)
-  mBot Self-drilling Screw (2)





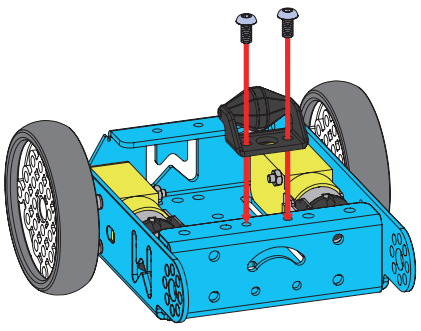

01 02
03 04

-  mBot Mini Wheel (1)
-  M4×8mm Screw (2)

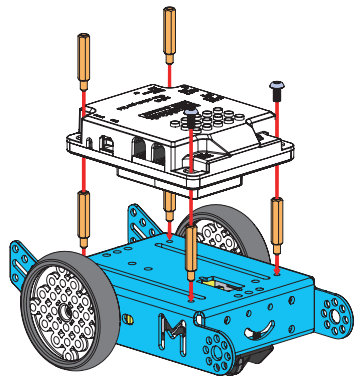





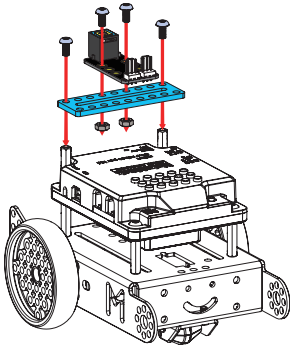

-  M4×25mm Brass Stud (6)
-  M4×8mm Screw (2)
-  mCore (1)



-  RJ25 Adapter Module (1)
-  Plate I1 (1)
-  M4 x 8mm Screw (4)
-  M4 Nut (2)



05

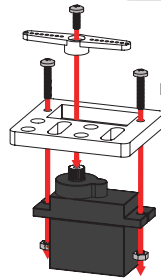

-  9g Micro Servo (1)
-  9g Micro Servo Bracket (1)
-  Servo Arm (1)
-  M2 x 5mm Screw (1)
-  M2 x 10mm Screw (2)
-  M2 Nut (2)

M2 x 5mm Screw



M2 x 10mm Screw

06

-  9g Micro Servo Hub (1)
-  M4 x 14mm Screw (2)
-  M4 Nut (2)

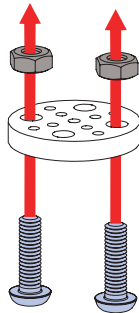

07



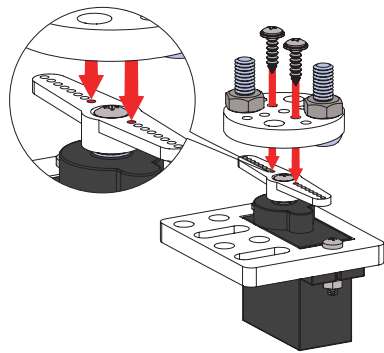

-  9g Micro Servo Self-drilling Screw (2)

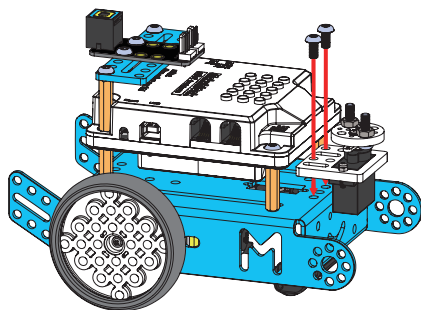

08

 M4 x 8mm Screw (2)



 mBot Ultrasonic Sensor (1)
 Bracket 3x3 (1)
 M4 x 8mm Screw (2)
 M4 Nut (2)

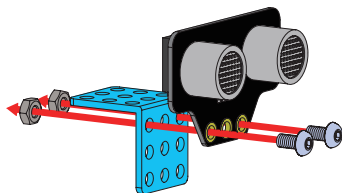

09 10

11

 M4 Nut (2)

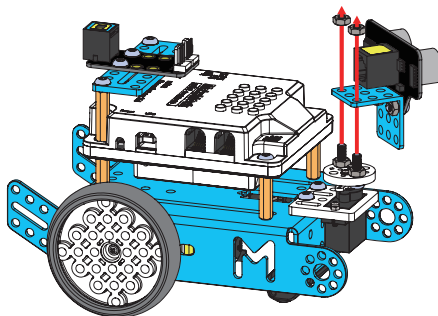

Please refer to the figure below to complete the wiring.

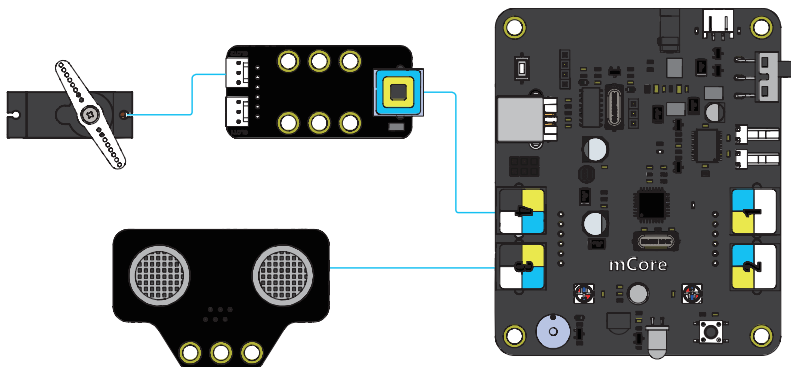

12



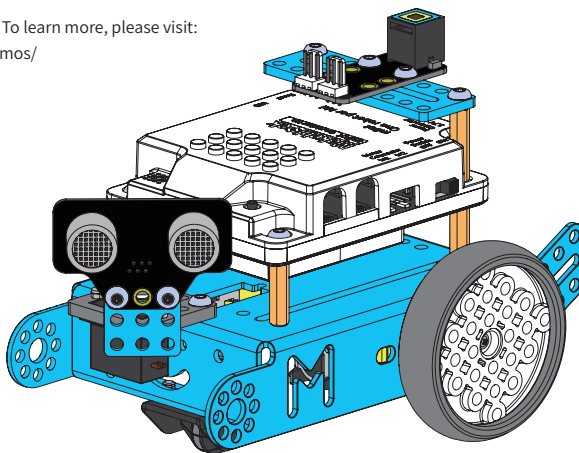

13

Good job!

You have finished the construction. To learn more, please visit:
<http://learn.makeblock.com/en/gizmos/>



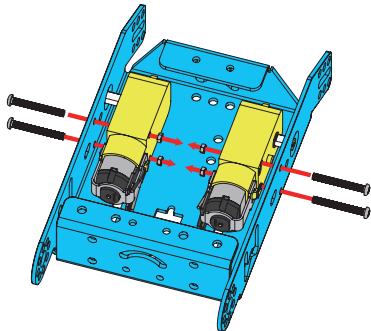

Light-Emitting Cat

-  mBot Chassis (1)
-  mBot Motor (2)
-  mBot M3×25mm Screw (4)
-  mBot M3 Nut (4)



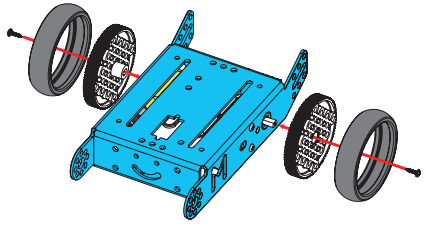

01

-   mBot Wheel (2)
-  mBot Self-drilling Screw (2)







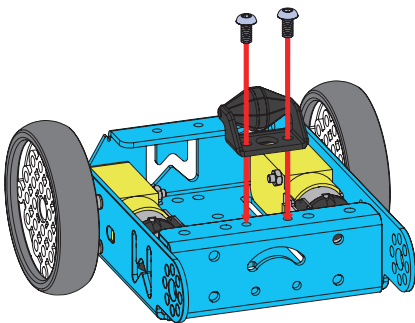

02

-  mBot Mini Wheel (1)
-  M4×8mm Screw (2)



03

-  9g Micro Servo (1)
-  9g Micro Servo Bracket (1)
-  Servo Arm (1)
-  M2×5mm Screw (1)
-  M2×10mm Screw (2)
-  M2 Nut (2)

M2×5mm Screw

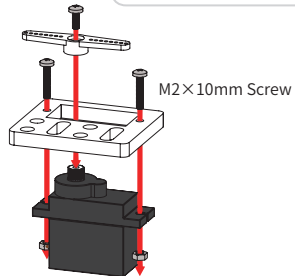

M2×10mm Screw

04

-  9g Micro Servo Hub (1)
-  M4x14mm Screw (2)
-  M4 Nut (2)

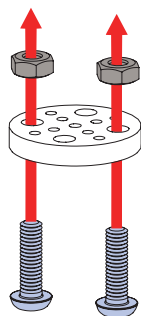

-  9g Micro Servo Self-drilling Screw (2)

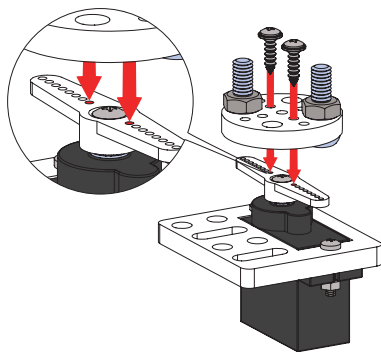

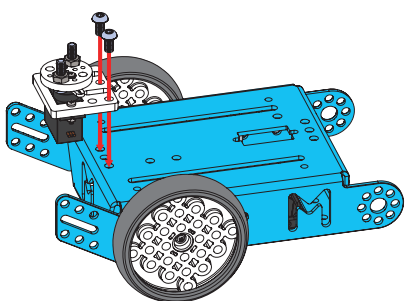

05 06

-  M4x8mm Screw (2)



07 08

-  Bracket 3x3 (1)
-  M4 Nut (2)

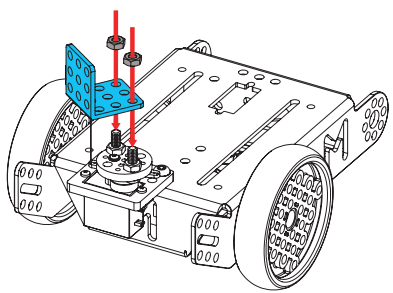



RGB LED Module (1)



M4 x 8mm Screw (2)



M4 Nut (2)

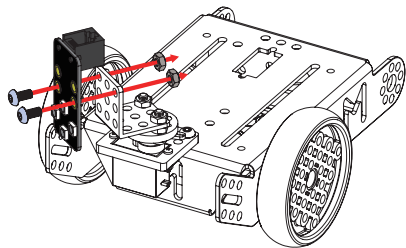

09

10



M4 x 25mm Brass Stud (6)



M4 x 8mm Screw (2)



mCore (1)

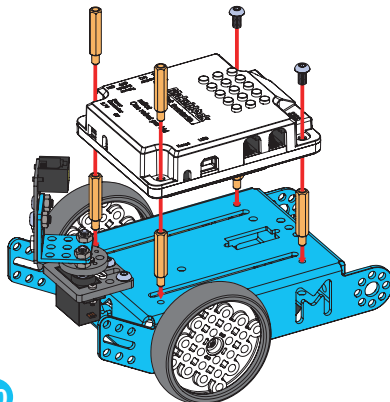

11



RJ25 Adapter Module (1)



Plate I1 (1)



M4 x 8mm Screw (4)



M4 Nut (2)

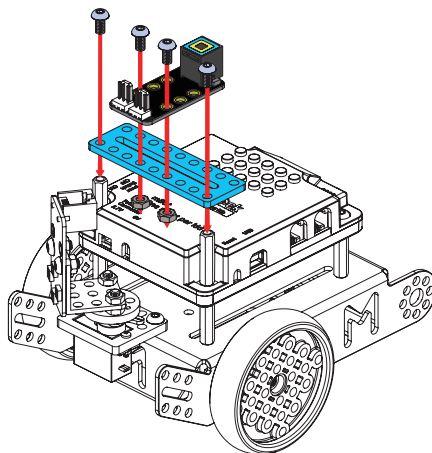

Please refer to the figure below to complete the wiring.

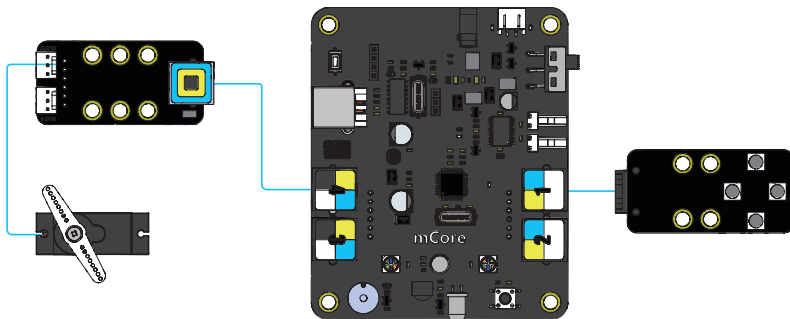

12



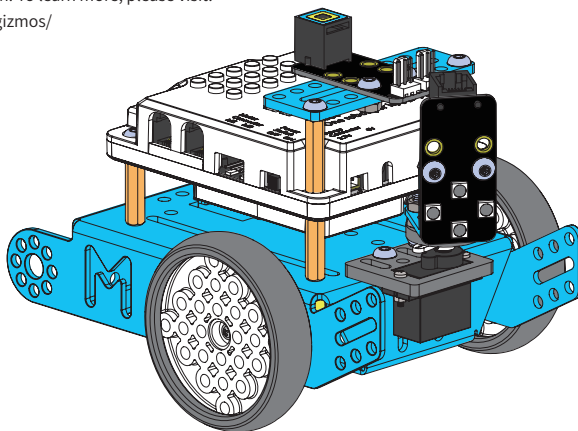

13

Good job!



You have finished the construction. To learn more, please visit:
<http://learn.makeblock.com/en/gizmos/>



Sunflower

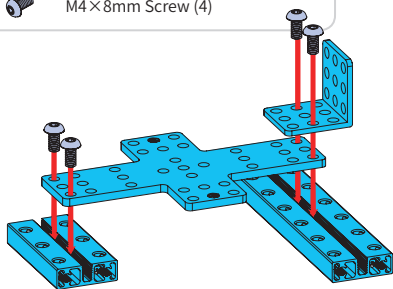

-  Ranger Plate for Battery Holder (1)
-  Ranger Beam 0824-48 (1)
-  Ranger Beam 0824-112 (1)
-  Bracket 3×3 (1)
-  M4×8mm Screw (4)



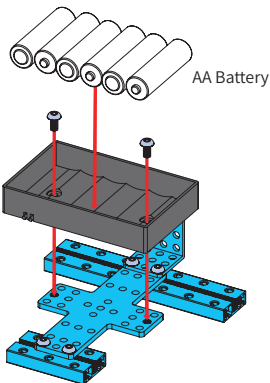



-  Ranger Battery Holder (1)
-  M4×8mm Screw (2)

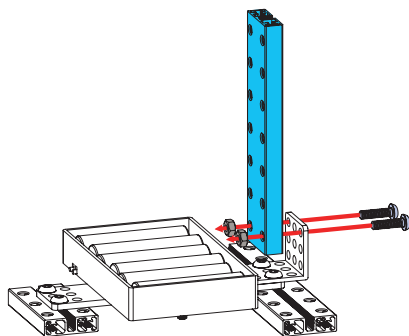

01 02

-  Ranger Beam 0824-112 (1)
-  M4×14mm Screw (2)
-  M4 Nut (2)



-  Ranger Plate 135° (2)
-  M4×22mm Screw (2)
-  M4 Nut (2)

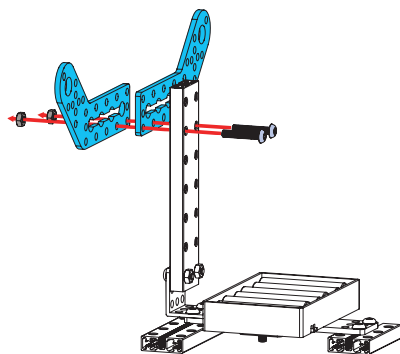

03 04



RJ25 Adapter Module (1)

M4 Nut (2)

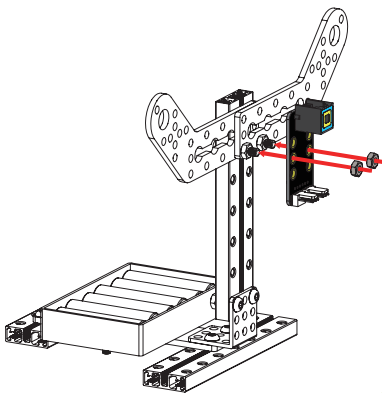

05



9g Micro Servo (1)



9g Micro Servo Bracket (1)



Servo Arm (1)



M2 x 5mm Screw (1)



M2 x 10mm Screw (2)



M2 Nut (2)

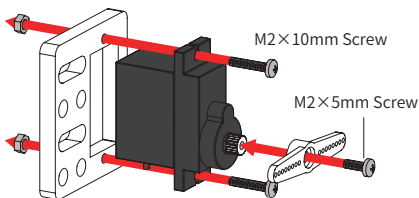

M2 x 10mm Screw

M2 x 5mm Screw

06



9g Micro Servo Hub (1)



M4 x 14mm Screw (2)



M4 Nut (2)

07

08

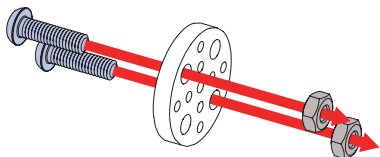

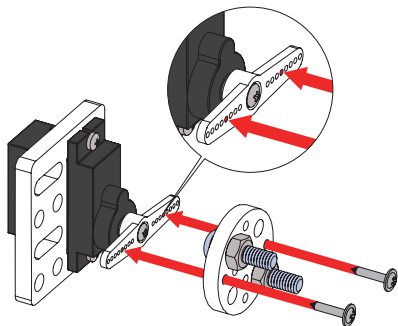

9g Micro Servo Self-drilling Screw (2)



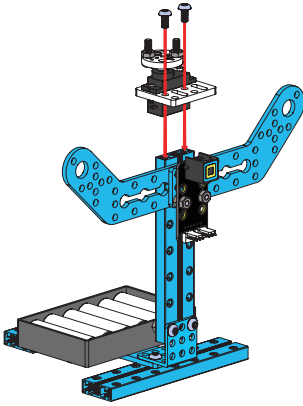

 M4 x 8mm Screw (2)

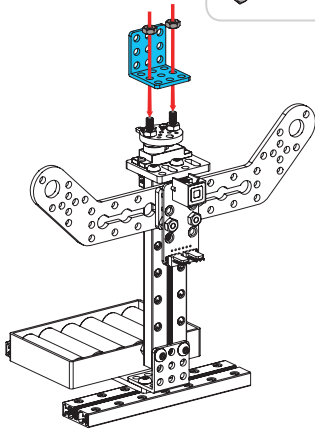

 Bracket 3 x 3 (1)
 M4 Nut (2)



09 10

 Me Auriga (1)
 Ranger Plate T-type (1)
 M4 x 8mm Screw (2)

11 12

 M4 x 8mm Screw (2)

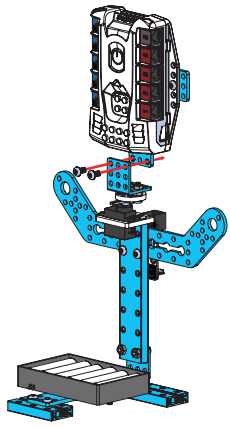
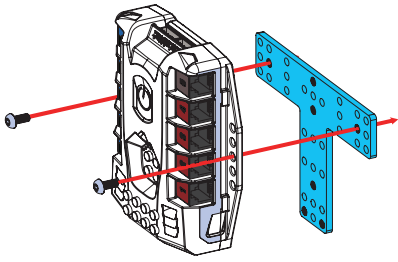

Please refer to the figure below to complete the wiring.

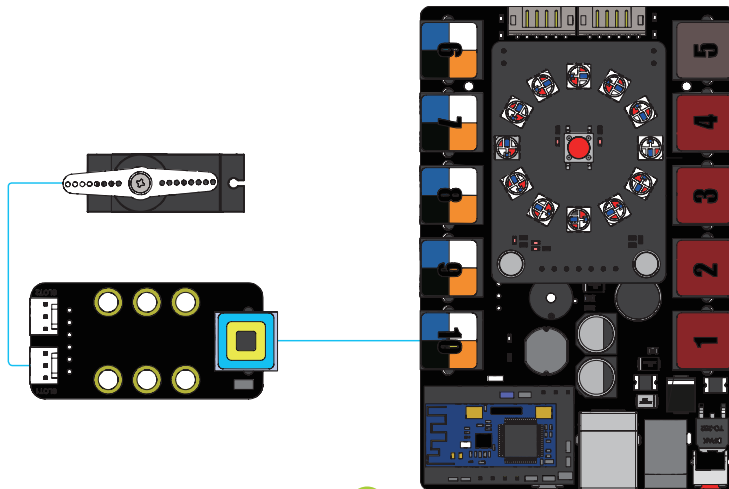

13





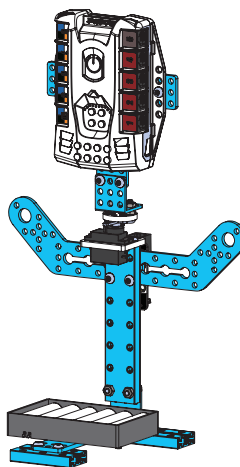

14

Good job!

You have finished the construction. To learn more, please visit:
<http://learn.makeblock.com/en/gizmos/>



Magic Stick

-  Me Auriga (1)
-  Ranger Plate T-type (1)
-  RJ25 Adapter Module (1)
-  Plate 45° (2)
-  M4 x 14mm Screw (4)
-  M4 Nut (4)

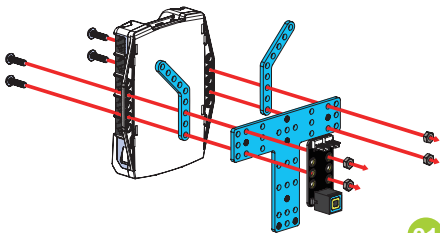

-  Ranger Beam 0824-112 (1)
-  M4 x 14mm Screw (2)



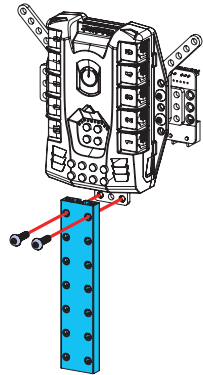



01



02

-  Ranger Bracket U1 (1)
-  M4 x 8mm Screw (2)

-  Micro Switch Bracket (1)
-  M4 x 14mm Screw (1)
-  M4 x 8mm Screw (1)
-  M4 Nut (1)

03

04

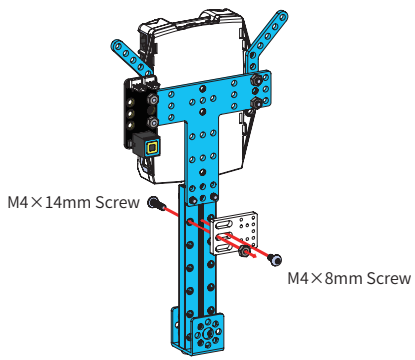
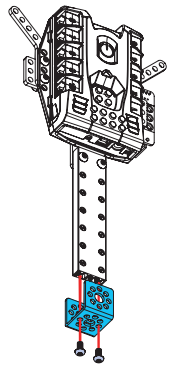



Micro Switch (1)



Micro Switch Cable (1)

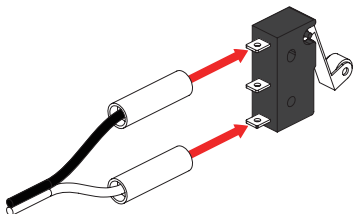

Micro Switch Self-drilling Screw (2)

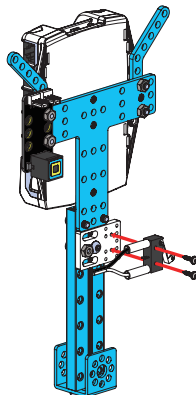

05

06



Ranger Battery Holder (1)



M4 x 8mm Screw (2)



Plastic Spacer 4 x 7 x 3mm (2)

07

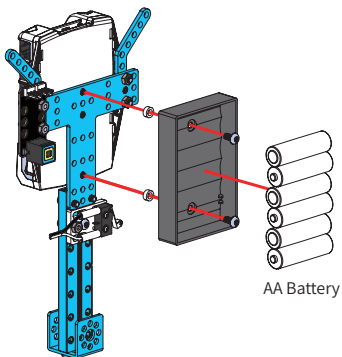

AA Battery

Please refer to the figure below to complete the wiring.

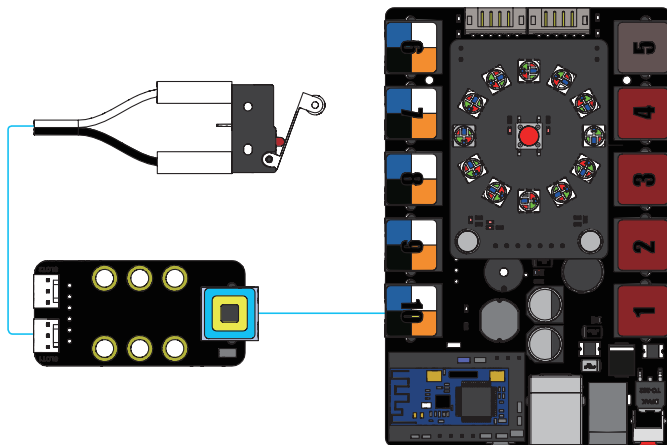

08

09

Good job!

You have finished the construction. To learn more, please visit:
<http://learn.makeblock.com/en/gizmos/>

